

USR-GPRS232-730 User Manual

File Version: V1.0.14.01



Contents

USR-GPRS232-730 User Manual	1
Brief Introduction	3
Features	3
1. Get Start	1
1.1. DTU Application	1
1.1.1. Application Diagram	1
1.1.2. Hardware Connection Diagram	2
1.2. Module Default Parameters	2
1.3. Basic Parameters	2
1.4. Hardware Introductions	3
1.5. Dimensions	3
2. Product Functions	5
2.1. APN	5
2.2. Work Mode	5
2.2.1. Transparent Mode	5
2.2.2. HTTPD Client Mode	6
2.2.3. SMS Mode	7
2.3. Serial Port	8
2.3.1. Parameters range	8
2.3.2. Serial Package Methods	8
2.3.3. RS485	8
2.3.4. Baud Rate Synchronization	8
2.4. Features	9
2.4.1. Identity Package Function	9
2.4.2. Heartbeat Package Function	9
2.4.3. Sleep mode	10
2.4.4. Location Based Service	10
2.4.5. LED Indicator	10
2.4.6. Reload by Hardware	10
3. Parameter Setting	11
3.1. AT Command	11
3.1.1. Serial AT Command	11
3.1.2. Transparent AT Command	11
3.1.3. SMS AT Command	11
4. Contact Us	12
5. Disclaimer	12
6. Update History	12

Brief Introduction

USR-GPRS232-730 is a GPRS DTU. User can realize the two-way data transparent transmission from the serial port to the network by simply setting it. USR-GPRS232-730 supports identity packages, heartbeat package, two Socket connections.

Features

- Supports GSM850/900, DCS1800/1900
- Supports GSM/GPRS/EDGE; Supports 2G flow of 2G/3G/4G SIM card
- Support two way Network connection simultaneously;Support TCP and UDP
- Every connection support 4KB Data Cache
- Supports sending network identity package
- Supports sending heartbeat package data to network or serial port
- Supports setting DTU parameters via SMS
- Supports 3 work modes: SMS transparent transmission mode, Network transparent transmission mode and HTTPD mode
- Supports sending CN/EN SMS via commands
- Automatic baud rate synchronization, can modify DTU serial parameters via network dynamically
- Support serial port RTS/CTS

1. Get Start

Product link:

<http://www.usriot.com/p/rs232-rs485-gsm-modems/>

USR-GPRS232-730 setting software, download address:

<http://www.usriot.com/usr-gm3-setup-software/>



RS232 / RS485 GSM GPRS Modem Supports SMS command

USR-GPRS232-730 is a RS232/RS485 to GSM modem, which used for data transparent transmission based on 2G Network.

Share



- 1 RS232 serial port and 1 RS485 serial port (not use simultaneously)
- Power: 5V~36V
- Quad-Band GSM/GPRS 850/900/1800/1900MHz
- Flow Control: CTS/RTS
- Work Mode: TCP/UDP Client

General Details
Parameter
Download

Picture 1 Download Page

If you have any question, please submit it back to customer center: <http://h.usriot.com>

1.1. DTU Application

1.1.1. Application Diagram

Data transmission diagram as follows:



Figure 1 Application diagram

1.1.2. Hardware Connection Diagram

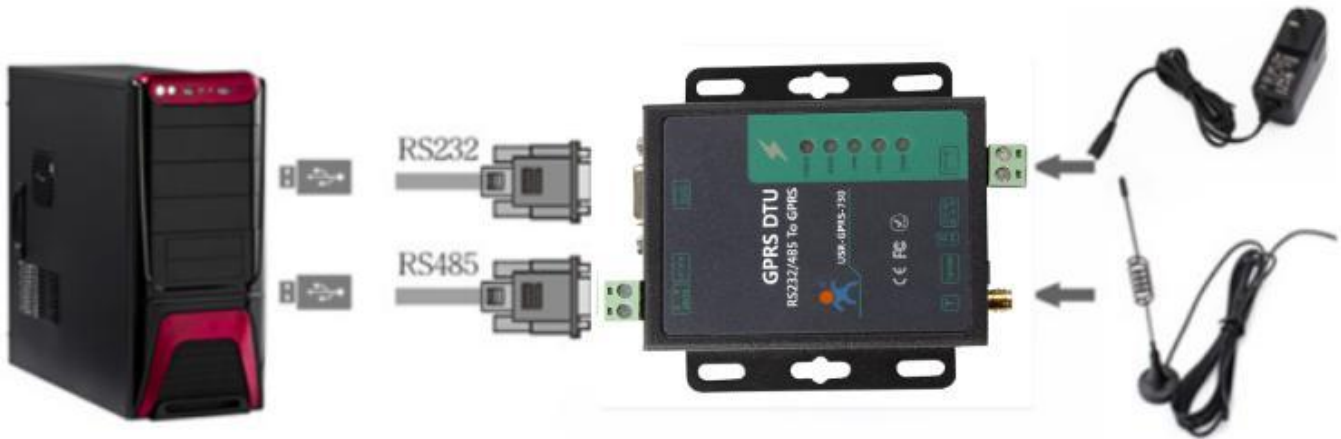

Figure 2 Hardware connection

1.2. Module Default Parameters

Work mode	Network Transparent transmission mode
Server Address	test.usr.cn
Server Port	2317
Serial Parameters	115200,8,1,None
Heartbeat Package	Package Data:www.usr.cn

Figure 3 Default parameters

1.3. Basic Parameters

	Parameter	Index
Wireless Parameters	Wireless Standards	GSM/GPRS/EDGE
	Standard frequency range	850/900/1800/1900MHz
	Max. Transmitted Power	GSM900 class4 (2W)
		DCS1800 class1 (1W)
	GPRS Terminal Device Class	Class B
	GPRS Multi-slot Class	GPRS Class 10
	GPRS Coding Schemes	CS1 ~ CS4
Hardware Parameters	Antenna	SMA Interface
	Data Interface	UART: 2400bps - 921600bps
	Working Voltage	DC 9V~24V

	Working Current	22mA-45mA(12V)
	Working Temp.	-25℃- 85℃
	Storage Temp.	-40℃- 125℃
	Dimension	80×84×25mm
Software Parameters	Wireless network type	GSM/GPRS/EDGE
	Work Mode	Transparent Mode, SMS Mode and HTTPD Client Mode
	Setting Command	AT+ Command Structure
	Network protocol	TCP /UDP/ DNS/HTTP
	Max. TCP connection	2
	User Configuration Method	Setting Software and AT command
Software Functions	DNS	Support
	Transparent Mode	TCP Client or UDP Client
	HTTP	HTTPD Client Mode
	SMS Mode	Support
	Heartbeat Data Package	To Serial port side or Network side
	Baud rate synchronization	Support
	Identity Package	Support user-defined, ICCID,IMEI, ID

Figure 4 Basic parameters

1.4. Hardware Introductions

Below is the hardware interface schematic diagram of USR-GPRS232-730:



Figure 5 hardware interface schematic diagram

Note: Two power interface can't be used simultaneously.

1.5. Dimensions

Below is the dimension figure of USR-GPRS232-730:

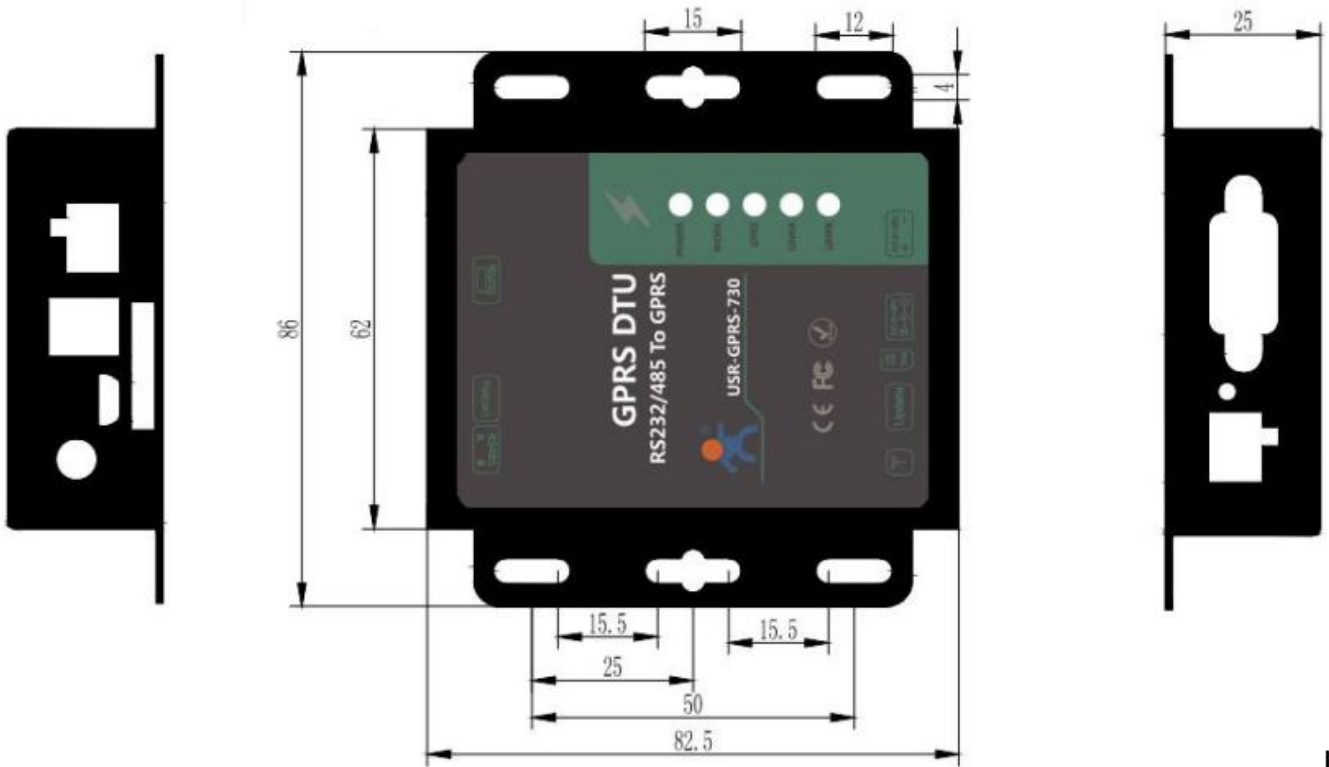

Figure 6 Dimension

2. Product Functions

This chapter introduces the functions of USR-GPRS232-730, as the following diagram shown, you can get an overall knowledge of it.

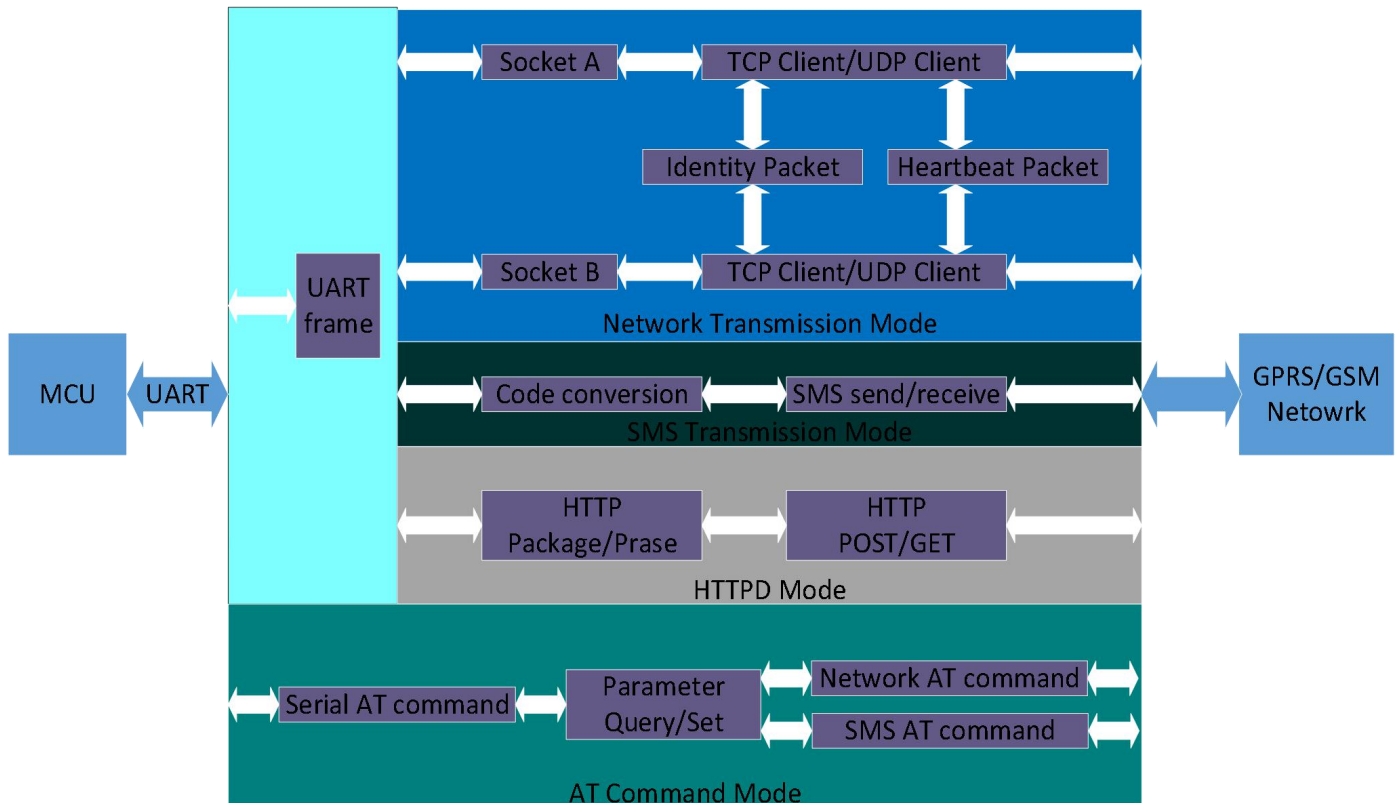

Figure 7 function diagram

2.1. APN

Different operator has different APN(access point name), If you use the SIM card from the operator. You must know the APN. You can ask your SIM card operator for APN.

There are three parameters about APN. Those are APN, username and password. Sometimes only configure APN is enough.

2.2. Work Mode

2.2.1. Transparent Mode

Transparent Mode: What you sent to serial will be forward to network. The communication is bidirectional.

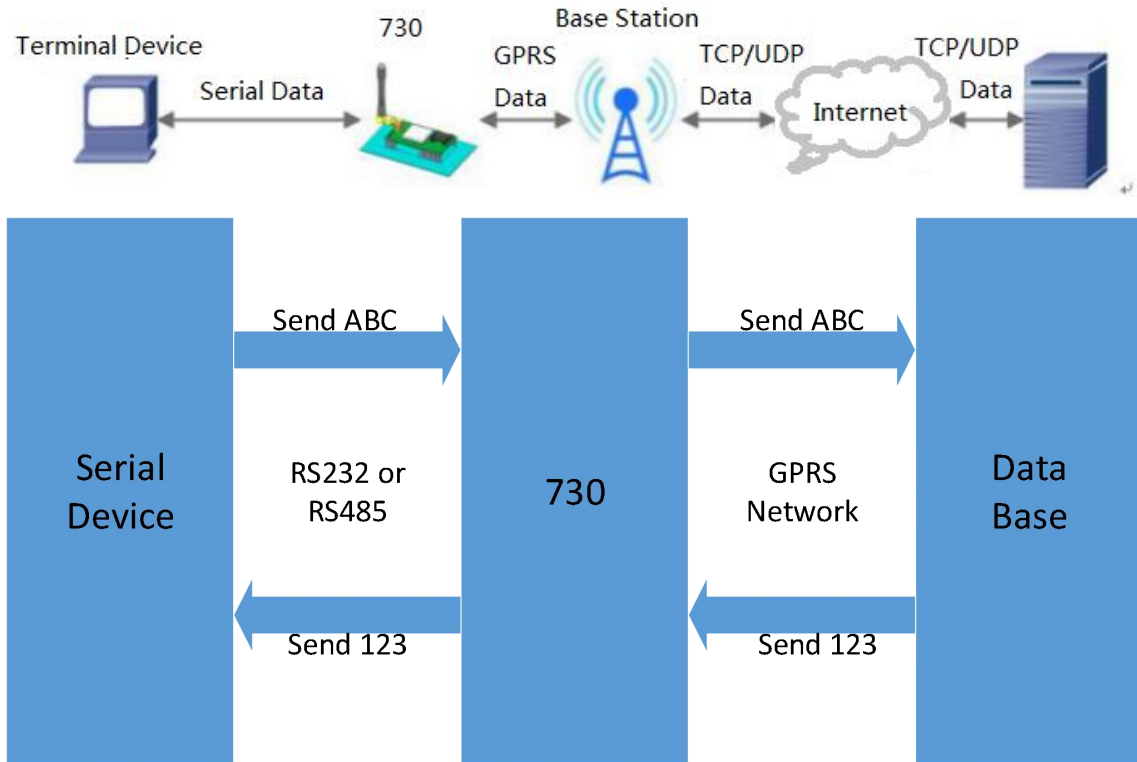

Figure 8 Transparent mode diagram

<Illustration>:

USR-GPRS232-730 supports 2 socket connections simultaneously: socket A and socket B, they are independent. This DTU only support working as TCP Client and UDP Client.

2.2.2. HTTPD Client Mode

HTTPD Client Mode: DTU will add the HTTP Header for every data from serial and transfer HTTP format data to Network. User needs to configure the HTTP Header before use this mode. User can use this mode transfer the serial data to HTTP server.

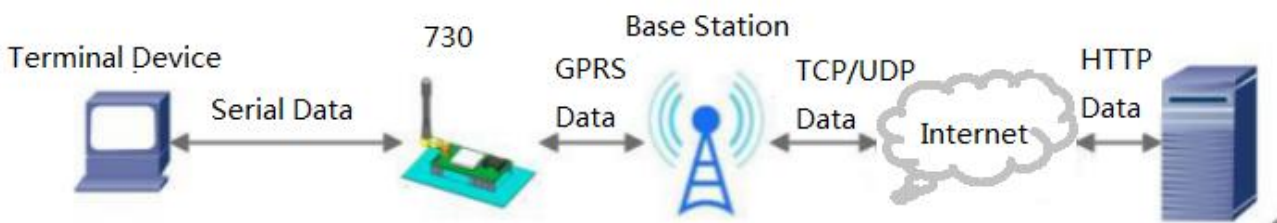

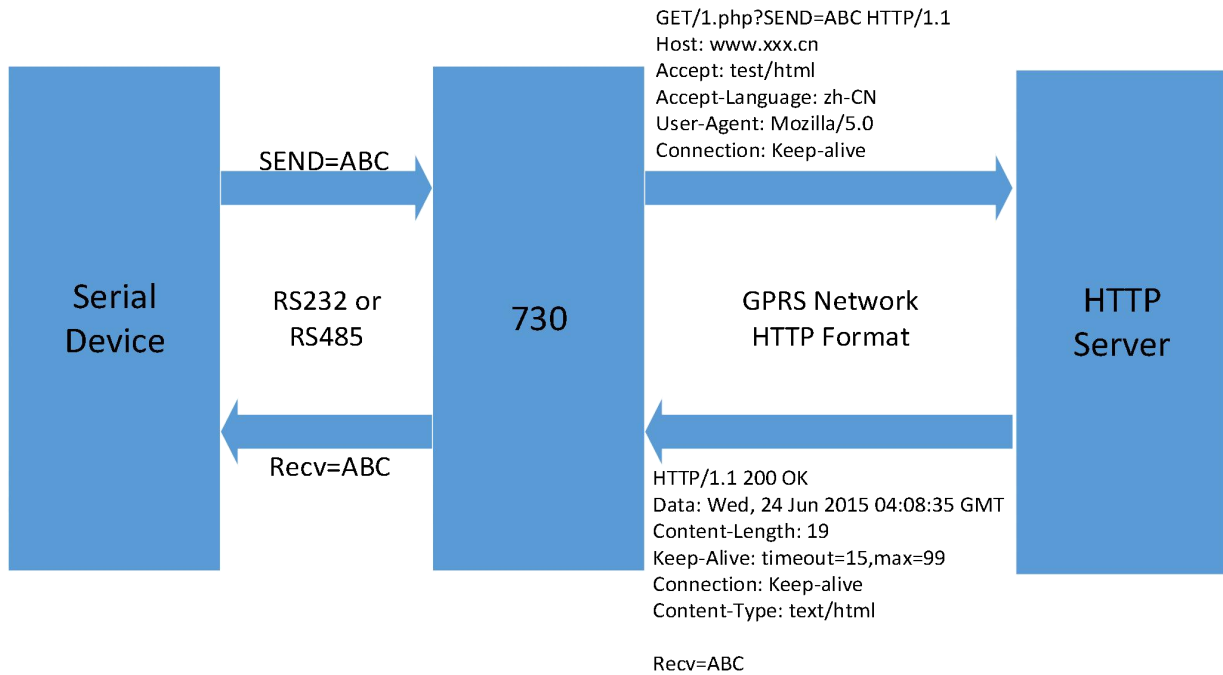

Figure 9 HTTPD Client Mode Diagram

<Note>:

DTU can't work as HTTP server.

2.2.3.SMS Mode

SMS Mode: Send serial data to mobile as SMS.

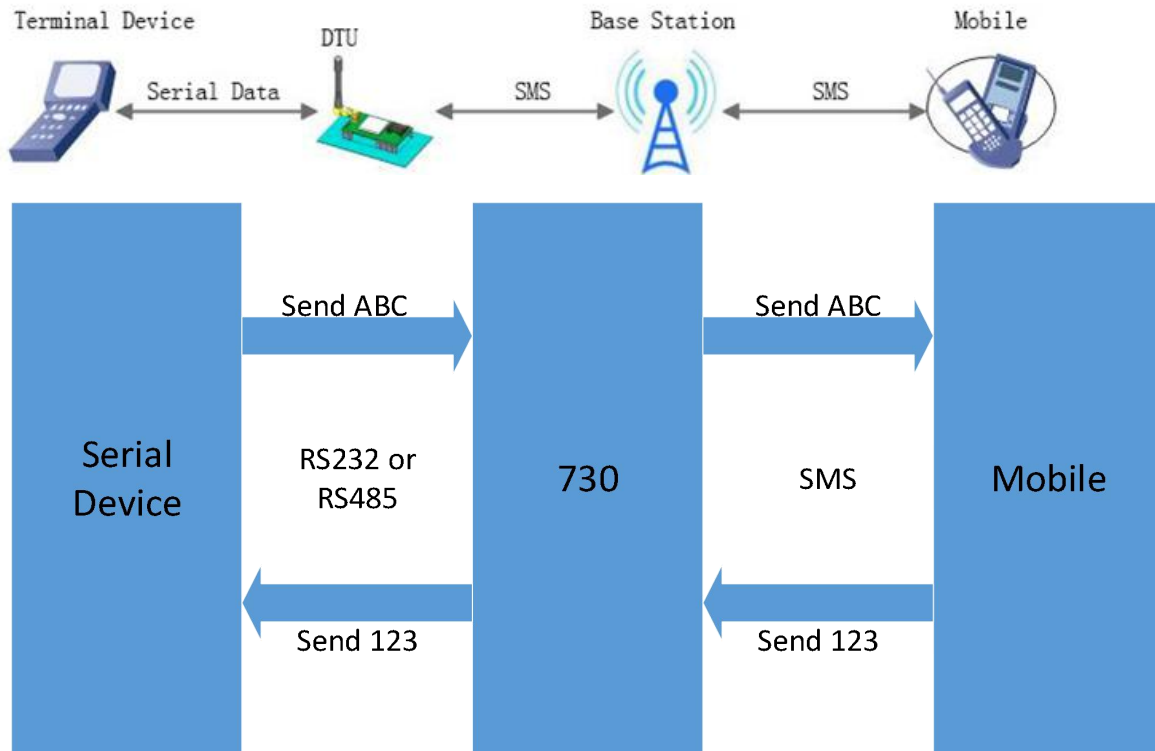

Figure 10 SMS Mode Diagram

2.3. Serial Port

2.3.1. Parameters range

Items	Parameters
Baud Rate	1200, 2400, 4800, 9600, 14400, 19200, 38400, 57600, 115200, 128000, 230400, 460800, 921600
Data Bits	7,8
Stop Bits	1,2
Parity Bits	NONE EVEN ODD
Flow Control/485	NFC: None Flow Control FC: Hardware Flow Control 485: When you use RS485, please choose this function

Figure 11 Serial parameters

2.3.2. Serial Package Methods

USR-GPRS232-730 adopts fixed Packaging time-200ms.

2.3.3. RS485

RS485 transfer time: For RS485 is half-duplex. It needs time to switch the status between sending & receiving. Switching period instructions:

Baud Rate	Switching period(ms)
2400	100
4800	40
9600	20
19200	15
28800	15
33600	15
38400	15
57600	15
115200	2
230400	2
460800	2
921600	2

Figure 12 Switching period

2.3.4. Baud Rate Synchronization

When module works with USR devices or software, serial parameter will change dynamically according to

network protocol. Customer can modify serial parameter by sending data conformed to specific protocol via network. It is temporary, when restart DTU, the parameters back to original parameters.

2.4. Features

2.4.1. Identity Package Function

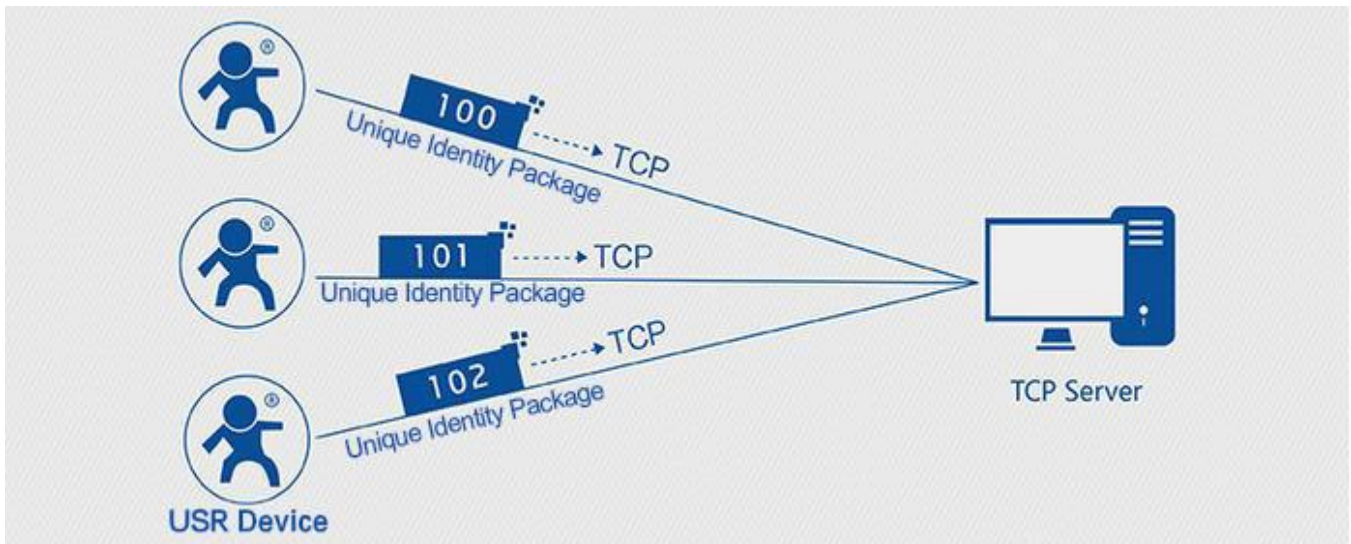

Figure 13 Identity Package

Identity Package is used for identify the device when module works as TCP client/UDP client. There are two methods for sending identity Package.

- Identity data will be sent when connection is established. (Only for TCP client)
- Identity data will be add on the front of every data package. (TCP client and UDP client)

Type of identity data: ICCID, IMEI, CLOUD and USER.

- ICCID, the unique identifier of SIM card, suitable to the application based on SIM card identification.
- IMEI, the unique identifier of DTU, suitable to the application based on device identification.
- CLOUD, the identification code based on USR CLOUD platform. For more information about USR Cloud, please go to cloud.usr.cn/en/
- USER, You can use your own identity data.

2.4.2. Heartbeat Package Function

Heartbeat Package: Module will output heartbeat data to serial port side or network side periodic. User can configure the heartbeat data and time interval. Serial heartbeat data can be used for polling Modbus data. Network heartbeat data can be used for showing connection status and keep the connection.

Heartbeat Package is only in transparent mode.

2.4.3. Sleep mode

Users can use the AT commands to set module into Sleep mode. In Sleep mode, module serial port can't receive data but can transmit data; module can receive data from network or SMS. Even though module in Sleep mode can also keep TCP connection, but user can use short connection or close connection temporarily to make power dissipation arrive best status.

User can use AT commands, phone call or wake-up pin to wake up module.

2.4.4. Location Based Service

LBS function: User can acquire approximate location of module through operator 's network. Accuracy error is about 100 meters and user can acquire LBS information by AT commands.

2.4.5. LED Indicator

LED Indicators of USR-GPRS232-730 are POWER, WORK, GPRS, LINKA, LINKB.

LED NAME	LED Status	Module Status
POWER	ON	Power on
	OFF	Power off
WORK	ON	Working
	OFF	Not Working
GPRS	ON	GPRS network is connected
	OFF	GPRS network is disconnected
LINKA	ON	Socket A is connected
	OFF	Socket A is disconnected
LINKB	ON	Socket B is connected
	OFF	Socket B is disconnected

Figure 14 LED indicator

2.4.6. Reload by Hardware

User default settings: User can save the settings as User default settings.

Pressed Reload button for 3~15 seconds, module will reload user default settings.

3. Parameter Setting

There are 3 ways to use AT commands for configuring module and querying status. They are serial AT command, SMS AT command and transparent AT command. We provide the setup software based on serial AT command. You can download the setup software from <http://www.usriot.com/usr-gm3-setup-software/>.

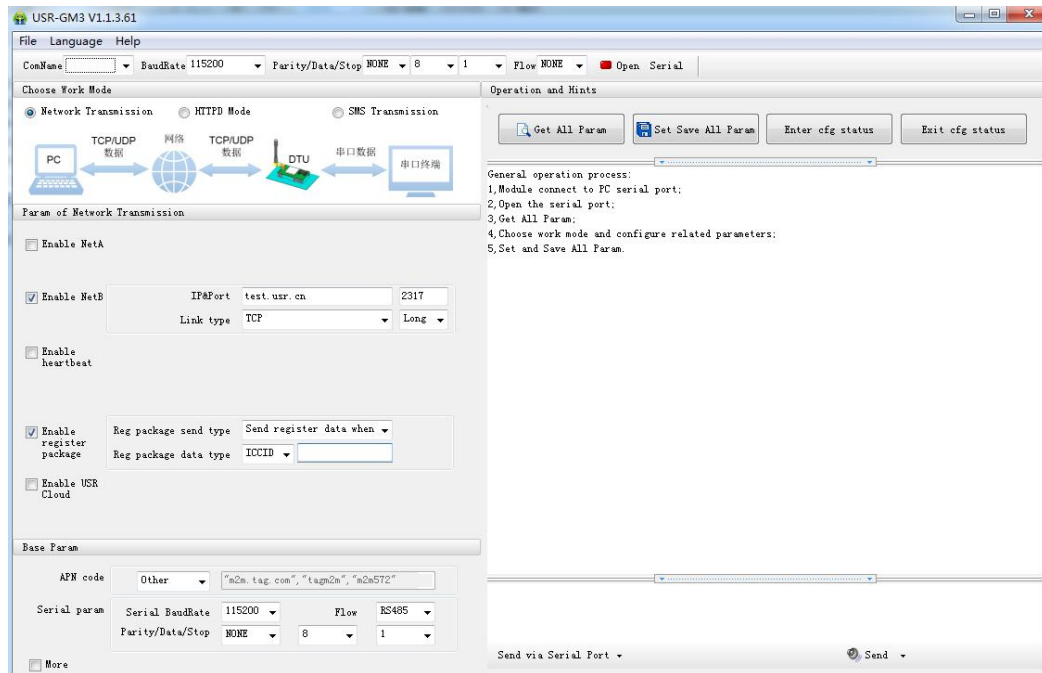

Figure 15 Setup software

3.1. AT Command

3.1.1. Serial AT Command

In transparent mode, SMS mode and HTTPD mode, you can enter serial AT command mode. Then you can send AT command to module. Setup software is based on this function. For entering AT command mode, please refer to this FAQ: <http://www.usriot.com/enter-serial-command-mode/>.

3.1.2. Transparent AT Command

When module in transparent mode, you can use “Password,AT command” format to send AT command via serial or network. If you use transparent AT command, you needn’t enter AT command mode.

3.1.3. SMS AT Command

You can configure module or query status by SMS AT command to remotely control your module in fields.

Note: SMS AT command can achieve sending more than one AT command by only one message after firmware version V3.0. User can achieve it by add “;” after each AT command.

4. Contact Us

Company: Jinan USR IOT Technology Limited

Address: Floor 11, Building 1, No. 1166 Xinluo Street, Gaoxin District, Jinan, Shandong, 250101, China

Web: www.usriot.com

Support: h.usriot.com

Email: sales@usr.cn

Tel: 86-531-88826739/86-531-55507297

5. Disclaimer

This document provide the information of USR-GPRS232-730 products, it hasn't been granted any intellectual property license by forbidding speak or other ways either explicitly or implicitly. Except the duty declared in sales terms and conditions, we don't take any other responsibilities. We don't warrant the products sales and use explicitly or implicitly, including particular purpose merchant-ability and marketability, the tort liability of any other patent right, copyright, intellectual property right. We may modify specification and description at any time without prior notice.

6. Update History

2017-07-14 V1.0.0.0 Established.

2017-08-02 V1.0.08.01 updated based on Chinese version user manual V1.0.08. Replacing functional block diagrams, correcting grammar mistakes and updating **3.1.3.SMS AT Command**.

2017-10-20 V1.0.14.01 updated based on Chinese version user manual V1.0.14. Replacing related hardware figures to latest hardware version figures and optimizing the overall arrangement